

Premium escutcheon blind
 Euro/Swiss Profile

Product description

- Access decision is made by the AAperio® escutcheon based on access data on card - access data are written on card via EAC system updater
- Can be used with all European (DIN) mortise locks - in wooden, steel and tubular-frame doors
- Main electronics (RFID + radio) outside - security-relevant electronics inside
- Outside handle rotates freely - inside handle always engaged
- LED for status visualisation





















Scope of delivery

- 1 escutcheon with battery (Lithium CR123A) and installation instructions
- Screws, drilling template and tool (for inserting cables)

Accessories/Individual parts

- Aperio PAP tool and wireless dongle 99 04_PAP tool
- Spare battery 99 0x_Battery
- Optional Covering plate - to cover existing boreholes 99 02_Coveringplate

Technical data - Premium escutcheon blind

	Approvals	CE, EN179, EN1906, DIN18273
	Dimension	312 x 41 x 10/20 mm (H x W x D)
	Version	Premium = Higher security version up to grade 3 (EN 1906) with approvals on fire (DIN18273), escape (EN179) route and security
	Handle	U-Shape
	Surface	Stainless steel brushed (ST)
	Distance	Spindle 9 mm; without distance
	Door leaf thickness	Door leaf between 35 and 95 mm thick, in 5 mm increments
	Backset	> 40 mm
	Battery	1 x Lithium CR123A
	Battery life	30 openings per day for 49 months
	Radio standard	IEEE 802.15.4 (2.4 GHz)
	Encryption (radio communication)	AES 128 bits
	Class of protection	IP 54
	Operating temperature range	-25°C to 60°C
	Relative humidity	< 85% (condensation-free)
	Status	LED (red/green/orange)
	RFID Technologies (Based on reader type)	MIFARE Classic® / MIFARE® DESFire® EV1
	RFID reading	UID / Sektor / Block / Application / File
	RFID Reading range	< 4 cm
	OSS Standard Offline	Optional available (MIFARE® DESFire®, LEGIC® Advant)

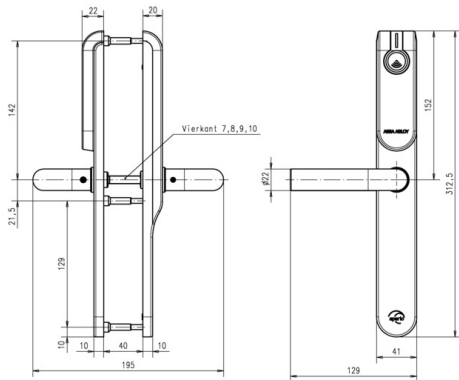
MIFARE™
CLASSIC® / DESFire™